

# LD74SR-OP



## High Power Ultra Shallow Recessed Downlight

Data sheet - Page 1

The LD74SR-OP is a little bit different! It does not use an optic and is supplied with an opal diffuser. The result is an exceptionally wide, diffused beam of light, giving an almost 175° wash. It is part of a new range of ultra shallow, high powered downlights designed to fit into ceilings with a minimal recess depth. The innovative horizontal heatsink plate allows the LD74SR-OP to fit into a 40mm ceiling depth. Applications for this product include display lighting and general illumination where an especially wide spread of light is required. Originally designed for yacht installations, this fitting can be specified with an extra red LED for night time navigation, and is IP54 rated as standard for use in wet environments.

### Key Features

- 175° beam of light
- Only 40mm ceiling depth required
- Innovative horizontal heatsink plate
- No spotting of LEDs with a glowing disc of light
- High power to size ratio
- 93 CRI LEDs
- IP54 as standard
- Hidden fixing with spring clips
- Designed for simple, quick installation
- Available with Switch, 0-10V, DMX, Dali or Mains dimmable drivers

### Specification

#### Applications



#### Beam Angle

175°

#### LED type

3 x Cree XPG2

#### Colour temperature

2700K\*\* / 3000K | 5000K

Drive Current (mA)	350	500	350	500
LED power* (W)	3.6	5.1	3.6	5.1
CRI (typical)	93	93	75	75
Forward voltage (V) <sub>100</sub>	9.0V	9.6V	9.0V	9.6V
Delivered lumens** (L <sub>100</sub> )	130	171	157	206

LED lifetime (to 70% lumen maintenance) 50,000hrs at a max ambient temperature of 35°C (if specifying fitting in ambient temperatures of up to 45°C run at 350mA max, LD74SR-OP-350)

#### Materials

Anodised aluminium body, stainless steel spring clips

#### Wiring

Comes pre-wired with either a 2 core or 4 core 350mm lead, can be specified with up to 10m at extra cost

#### Diffuser

3mm 030 Opal Perspex

#### IP rating

IP54

\*LED wattage includes losses associated with using an 85% efficient driver

\*\*2700K lumen output is 12% lower than the 3000K figure listed

4000K lumen output is 14% higher than the 3000K figure listed (80 CRI)

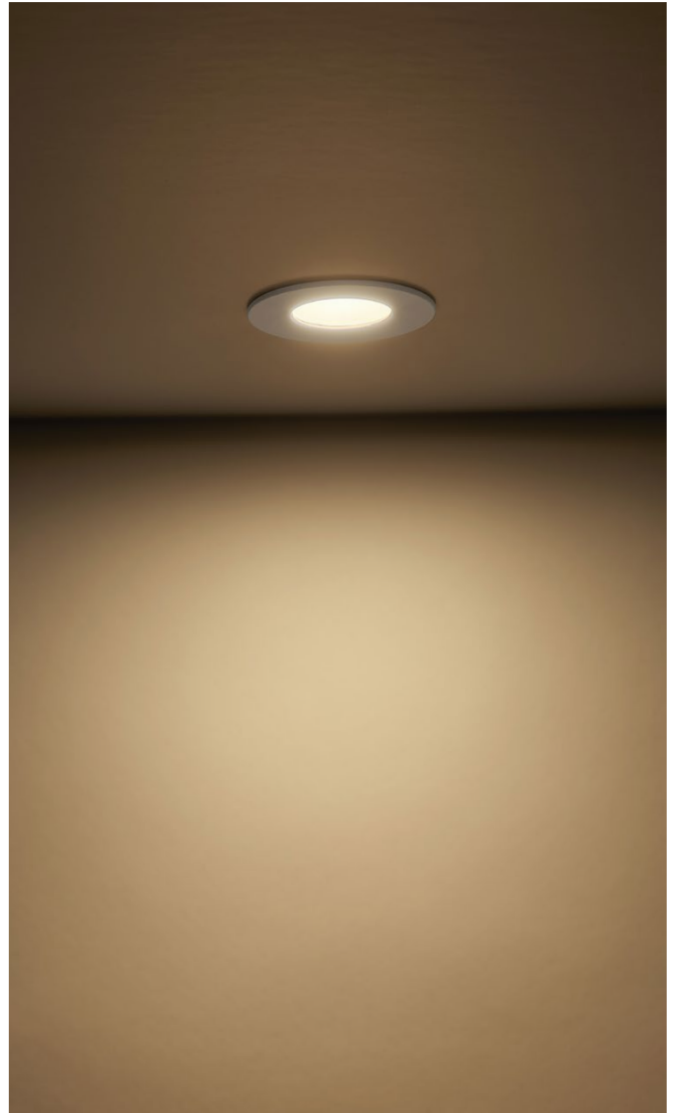

# LD74SR-OP



High Power Ultra Shallow Recessed Downlight

Data sheet - Page 2

## Dimensions

Cross section view

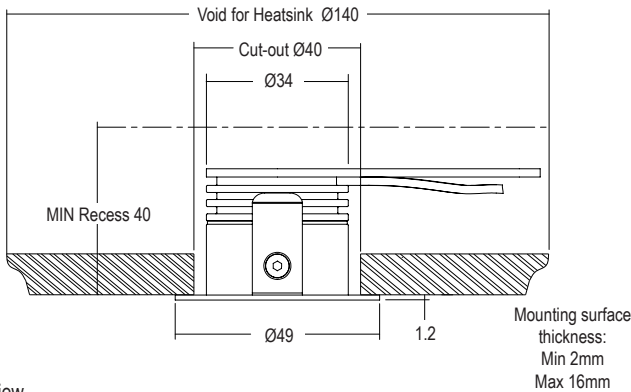

Side view

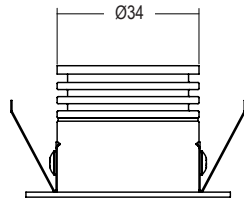

Top view

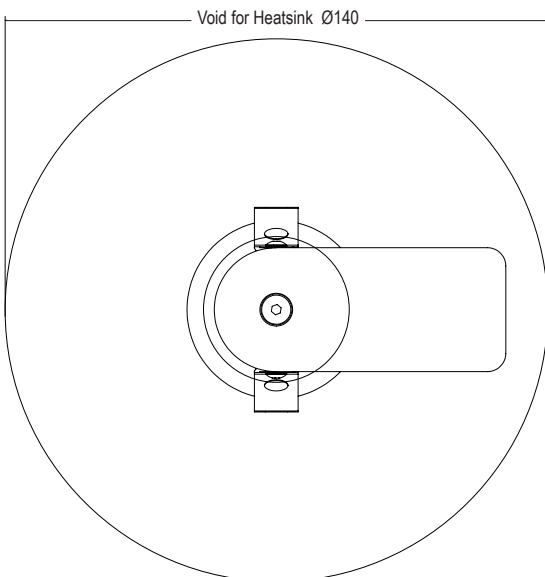

## Red navigation circuit

For yacht applications in areas where a night time red navigation light is required, the LD74SR-OP can be supplied with the standard 3 white light LED cluster and an additional single red LED on a second circuit. It is supplied with a 4 core cable (2 circuits) and requires 2 drivers. Please see our driver guide for the quantities of LD74SR-OPs that each driver can run.



## Order Codes and Options

Product code	LED colour	Finish
LD74SR-OP - 350 - 500		

Example: LD74SR-OP-350 / LW30+LR / White

### Product codes with output options

350mA 3.6W	LD74SR-OP-350
500mA 5.1W	LD74SR-OP-500

### LED colour options

Extra Warm White (2700K)	/LW27
Warm White (3000K)	/LW30
White (4000K) - on request	/LW40
Cool White (5000K)	/LW50
Optional secondary red navigation circuit	/LW**+LR
Blue	/LB
Green	/LG
Red	/LR
Amber	/LA

### Finish options

Bezel - Paint finish white (RAL 9016) / black / RAL  
Chrome finish (minimum order - please contact us)

### Use with 350mA, 500mA and 700mA constant current LED drivers

We have a wide range of dimmable LED drivers, 0-10V, DMX, DALI and Mains dimmable. Please see the downloads section on our website:

To run 1-4 LD74SR-OP-350 in series use a TXDEL350D (0-10V dimmable)

To run 1-4 LD74SR-OP-500 in series use a TXDEL500D (0-10V dimmable)